

## **WINDOW-TYPE ROOM AIR CONDITIONER**

---

# **Owner's Manual & Installation Manual**

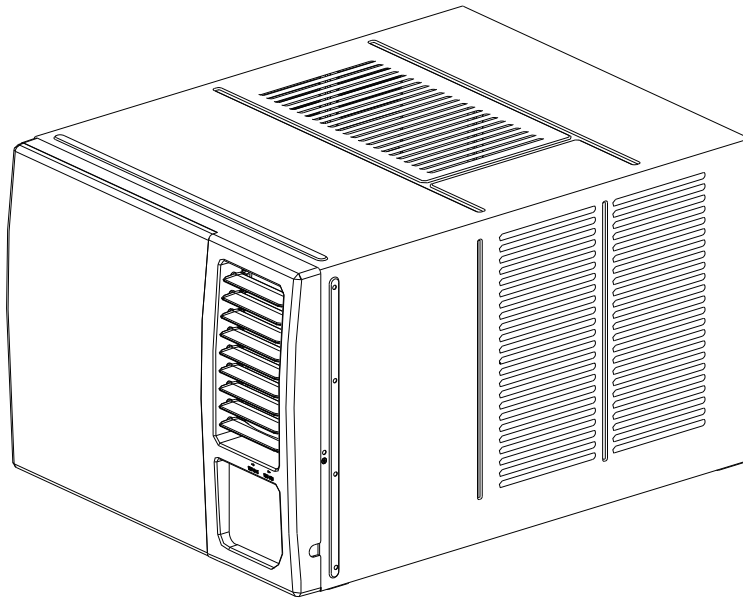

### **IMPORTANT NOTE:**

Read this manual carefully before installing or operating your new air conditioning unit. Make sure to save this manual for future reference.

Please check the applicable models, technical data from the nameplate pasted on the unit.

# Table of Contents

|                                     |    |
|-------------------------------------|----|
| Safety Precautions .....            | 03 |
| Unit Parts Identification .....     | 05 |
| Care and Maintenance.....           | 07 |
| Water Drainage .....                | 08 |
| Installation Instructions .....     | 09 |
| Troubleshooting.....                | 11 |
| Specifications .....                | 12 |
| Packing and unpacking the unit..... | 12 |

## European Disposal Guidelines

This marking shown on the product or its literature, indicates that waste electrical and electrical equipment should not be mixed with general household waste.

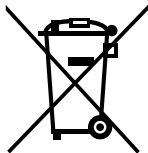

### Correct Disposal of This Product (Waste Electrical & Electronic Equipment)

This appliance contains refrigerant and other potentially hazardous materials. When disposing of this appliance, the law requires special collection and treatment. **Do not** dispose of this product as household waste or unsorted municipal waste.

When disposing of this appliance, you have the following options:

- Dispose of the appliance at designated municipal electronic waste collection facility.
- When buying a new appliance, the retailer will take back the old appliance free of charge.
- The manufacturer will take back the old appliance free of charge.
- Sell the appliance to certified scrap metal dealers.

### Special notice

Disposing of this appliance in the forest or other natural surroundings endangers your health and is bad for the environment. Hazardous substances may leak into the ground water and enter the food chain.

# Safety Precautions

## Read Safety Precautions Before Operation and Installation

**Incorrect installation due to ignoring instructions can cause serious damage or injury.**

The seriousness of potential damage or injuries is classified as either a **WARNING** or **CAUTION**.



### **WARNING**

This symbol indicates the possibility of personnel injury or loss of life.



### **CAUTION**

This symbol indicates the possibility of property damage or serious consequences.



### **WARNING**

This appliance can be used by children aged from 8 years and above and persons with reduced physical, sensory or mental capabilities or lack of experience and knowledge if they have been given supervision or instruction concerning use of the appliance in a safe way and understand the hazards involved. Children shall not play with the appliance. Cleaning and user maintenance shall not be made by children without supervision (EN Standard requirements).

This appliance is not intended for use by persons (including children) with reduced physical, sensory or mental capabilities, or lack of experience and knowledge, unless they have been given supervision or instruction concerning use of the appliance by a person responsible for their safety. Children should be supervised to ensure that they do not play with the appliance.



### **WARNINGS FOR PRODUCT USE**

- If an abnormal situation arises (like a burning smell), immediately turn off the unit and disconnect the power. Call your dealer for instructions to avoid electric shock, fire or injury.
- **Do not** insert fingers, rods or other objects into the air inlet or outlet. This may cause injury, since the fan may be rotating at high speeds.
- **Do not** use flammable sprays such as hair spray, lacquer or paint near the unit. This may cause fire or combustion.
- **Do not** operate the air conditioner in places near or around combustible gases. Emitted gas may collect around the unit and cause explosion.
- **Do not** operate your air conditioner in a wet room such as a bathroom or laundry room. Too much exposure to water can cause electrical components to short circuit.
- **Do not** expose your body directly to cool air for a prolonged period of time.
- **Do not** allow children to play with the air conditioner. Children must be supervised around the unit at all times.
- If the air conditioner is used together with burners or other heating devices, thoroughly ventilate the room to avoid oxygen deficiency.
- In certain functional environments, such as kitchens, server rooms, etc., the use of specially designed air-conditioning units is highly recommended.
- Unplug the unit or disconnect the power supply to the unit if strange sounds, smell, or smoke comes from it.
- To further optimize the performance of your unit, keep doors and windows closed during operation.
- Pay attention when unpacking and installing. Sharp edges could cause injury.

### **CLEANING AND MAINTENANCE WARNINGS**

- Turn off the device and disconnect the power before cleaning. Failure to do so can cause electrical shock.
- **Do not** clean the air conditioner with excessive amounts of water.
- **Do not** clean the air conditioner with combustible cleaning agents. Combustible cleaning agents can cause fire or deformation.



### **CAUTION**

- Turn off the air conditioner and disconnect the power if you are not going to use it for a long time.
- Turn off and unplug the unit during storms.
- Make sure that water condensation can drain unhindered from the unit.
- **Do not** operate the air conditioner with wet hands. This may cause electric shock.
- **Do not** use device for any other purpose than its intended use.
- **Do not** climb onto or place objects on top of the outdoor unit.
- **Do not** allow the air conditioner to operate for long periods of time with doors or windows open, or if the humidity is very high.



## ELECTRICAL WARNINGS

- Only use the specified power cord. If the power cord is damaged, it must be replaced by the manufacturer, its service agent or similarly qualified persons in order to avoid a hazard.
- Keep power plug clean. Remove any dust or grime that accumulates on or around the plug. Dirty plugs can cause fire or electric shock.
- **Do not** pull power cord to unplug unit. Hold the plug firmly and pull it from the outlet. Pulling directly on the cord can damage it, which can lead to fire or electric shock.  
**Do not** modify the length of the power supply cord or use an extension cord to power the unit.
- **Do not** share the electrical outlet with other appliances. Improper or insufficient power supply can cause fire or electrical shock. Always install circuit breaker and a dedicated power circuit.
- **Do not** use the socket if it is loose or damaged.
- **Do not** place heavy object on the power cord and ensure that the cord is not compressed.  
There is danger of fire or electric shock.
- If water enters the unit, turn the unit off at the power outlet and switch off the circuit breaker.  
Isolate supply by taking the power-plug out or disconnect the power supply to the unit, contact a qualified service technician.
- The product must be properly grounded at the time of installation, or electrical shock may occur.
- For all electrical work, follow all local and national wiring standards, regulations, and the Electrical Connection Diagram located on the top panel of the unit.
- If connecting power to fixed wiring, an all-pole disconnection device which has at least 3mm clearances in all poles, and have a leakage current that may exceed 10mA, the residual current device(RCD) having a rated residual operating current not exceeding 30mA, and disconnection must be incorporated in the fixed wiring in accordance with the wiring rules.
- This unit is earthed through the power cord, make sure that the unit is correctly grounded. The wall outlet(Air-break switch) should be provided with reliable earth wire.
- The unit should be provided with an individual circuit and the circuit breaker/fuse rating should be the same as that of the power cord and wall outlet. Power cord conductors are distinguished according to the color as shown in Wiring Diagram located on the top of the machine.

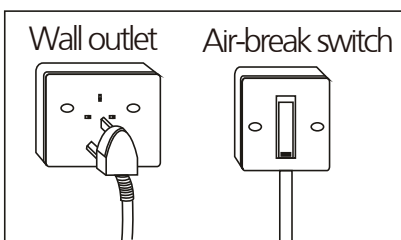

## TAKE NOTE OF FUSE SPECIFICATIONS

The air conditioner's circuit board (PCB) is designed with a fuse to provide overcurrent protection. The specifications of the fuse are printed on the circuit board, such as T3.15A/250V(or 350V), etc,



## WARNINGS FOR PRODUCT INSTALLATION

1. Installation must be performed by an authorized dealer or specialist. Defective installation can cause water leakage, electrical shock, or fire.
2. Installation must be performed according to the installation instructions. Improper installation can cause water leakage, electrical shock, or fire. (In North America, installation must be performed in accordance with the requirement of NEC and CEC by authorized personnel only.)
3. Contact an authorized service technician for repair or maintenance of this unit. This appliance shall be installed in accordance with national wiring regulations.
4. Only use the included accessories, parts, and specified parts for installation. Using non-standard parts can cause water leakage, electrical shock, fire, and can cause the unit to fail.
5. Install the unit in a firm location that can support the unit's weight. If the chosen location cannot support the unit's weight, or the installation is not done properly, the unit may drop and cause serious injury and damage.
6. Install drainage piping according to the instructions in this manual. Improper drainage may cause water damage to your home and property.
7. For units that have an auxiliary electric heater, do not install the unit within 1 meter (3 feet) of any combustible materials.
8. **Do not** install the unit in a location that may be exposed to combustible gas leaks. If combustible gas accumulates around the unit, it may cause fire.
9. **Do not** turn on the power until all work has been completed.
10. When moving or relocating the air conditioner, consult experienced service technicians for disconnection and reinstallation of the unit.
11. How to install the appliance to its support, please read the information for details in "Installation instructions" section.

## Note about Fluorinated Gasses

1. Fluorinated greenhouse gases are contained in hermetically sealed equipment. For specific information on the type, the amount and the CO<sub>2</sub> equivalent in tonnes of the fluorinated greenhouse gas (on some models), please refer to the relevant label on the unit itself.
2. Installation, service, maintenance and repair of this unit must be performed by a certified technician.
3. Product uninstallation and recycling must be performed by a certified technician.

## Operating temperature

When your air conditioner is used outside of the following temperature ranges, certain safety protection features may activate and cause the unit to disable.

|                   |                     |                        |
|-------------------|---------------------|------------------------|
| Cooling operation | Outdoor Temperature | 18°C-43°C (64°F-109°F) |
|                   | Indoor Temperature  | 17°C-32°C (62°F-90°F)  |
| Heating operation | Outdoor Temperature | -5°C-24°C (23°F-76°F)  |
|                   | Indoor Temperature  | 0°C-27°C (32°F-80°F)   |

### To further optimize the performance of your unit, do the following:

- Keep doors and windows closed.
- The capacity of the room air conditioner must fit the room size for efficient and satisfactory operation.
- Do not block air inlets or outlets.
- Regularly inspect and clean air filters.
- If the power supplied to the unit is not plus/minus 10% of the specified rating, the unit may not function and the fuse may blow.
- Noise from the air conditioner will be louder at night than in the daytime. This is because the noise in the surroundings is comparatively low at night. If you feel that the noise is too loud, switch the thermostat to lower numbers.

## UNIT PARTS IDENTIFICATION

NOTE: Different models have different front panels and cabinets. Illustrations in this manual are for explanatory purposes. The actual shape of your indoor unit may be slightly different. The actual shape shall prevail. See the following figures for references:

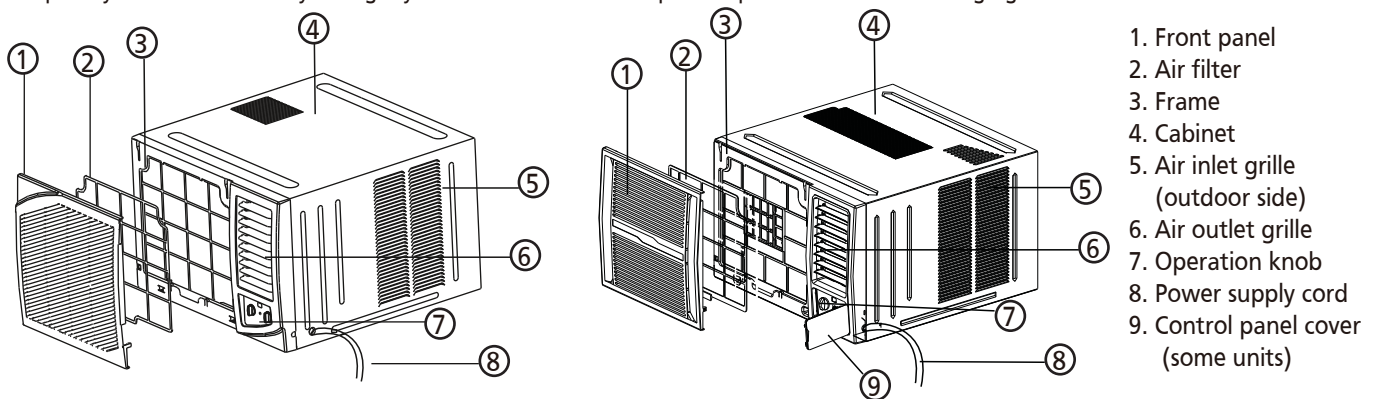

### Accessories

Seal(※)  
 (Used on  
 drain joint)



1 pc

Drain Joint(※)



1 pc

Drain pan(※)

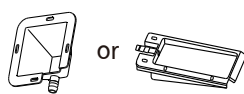

1 pc

Rubber Plug



1~2 pc  
 (depending on  
 models)

Screw



2 pcs (For some units, used  
 to fasten the front panel)  
 2 pcs or 4 pcs (used to install  
 the drain pan)

PVC sheath and  
 cable ties(※)

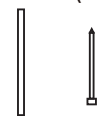

1 pc

4 pcs

[※] Model dependent

## Vent Control

The vent control is located above the control knobs. The operation method and the shape may vary in different models (see the following figures)

For maximum cooling efficiency, CLOSE the vent. It will allow internal air circulation. OPEN the vent to discharge stale air.

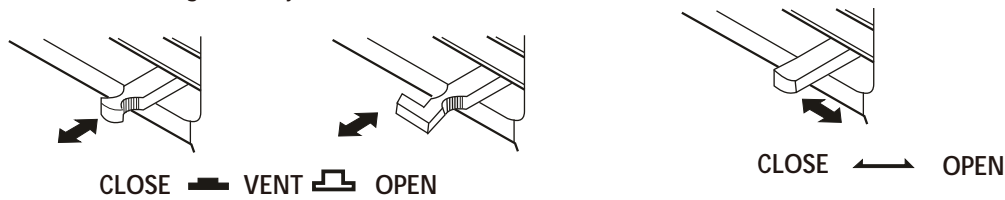

**NOTE:** The vent control is not available for all the units. Some units do not have vent control.

## Operation panel

**NOTE:** Different models have different operation panels. Not all the functions describing below are available for the air conditioner you purchased. Please check the operation panel of the unit you purchased. The following graphics are for explanatory purposes. The actual shape shall prevail.

| Controller | Position                                    | Description   |
|------------|---|---|
| THERMOSTAT | 1-12<br>min-max cooler                      | As the knob is turned clockwise, the higher number (higher cool settings) on the dial indicate lower temperature.       |
|            | Test  | Used to test the compressor and make sure the unit is working properly. Do not use this position for regular operation. |
| SELECTOR   | OFF   | The air conditioner is switched off.  |
|            | FAN   | Fan only operates at high speed, without cooling effect.  |
|            | LOW FAN                                     | Fan only operates at low speed, without cooling effect.   |
|            | MED FAN                                     | Fan only operates at low speed, without cooling effect.   |
|            | HIGH FAN                                    | Fan only operates at high speed, without cooling effect.  |
|            | LOW COOL                                    | Minimum cooling effect with low fan speed.  |
|            | MED COOL                                    | Intermediate cooling effect with Med fan speed.   |
|            | HIGH COOL                                   | Maximum cooling effect with high fan speed.   |
|            | LOW HEAT                                    | Minimum heating effect with low fan speed.  |
| HIGH HEAT  | Maximum heating effect with high fan speed. |   |

**NOTE:**

**POWER indicator light (if any):**

This indicator light remains on when the unit is on and goes off when the SELECTOR is set to "OFF" position.

**COMP. indicator light (if any):**

This indicator light shows the status of the compressor. It lights up when the compressor starts, and it turns off when the compressor stops.

## How to operate

The THERMOSTAT and SELECTOR of the air conditioner you purchased may be look like one of the following, the actual shape shall prevail:

### THERMOSTAT

Turn the thermostat control clockwise to lower the temperature.

Turn the thermostat control counterclockwise to increase the temperature.

The thermostat is used to set the desired room temperature when the unit is operating under the COOL mode.

When the room temperature is higher than the thermostat setting, the compressor is automatically switched on to provide a cool effect. When the room temperature is lower than the thermostat setting, the compressor is automatically switched off to stop cooling.

**NOTE:** For the unit adopts PTC heater, when the SELECTOR is set to HIGH HEAT or LOW HEAT, the THERMOSTAT is disabled. You cannot use the THERMOSTAT to adjust the temperature.

**IMPORTANT:** When restarting the cooling operation after it has been turned off by either SELECTOR or THERMOSTAT, be sure to allow at least 3 minutes. Otherwise, the fuse may blow due to an overload of the unit.

### THERMOSTAT

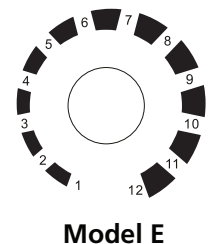
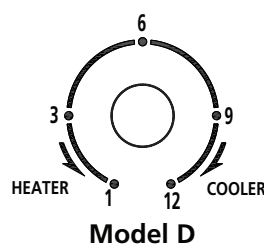
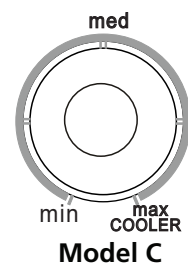
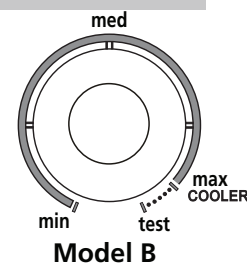
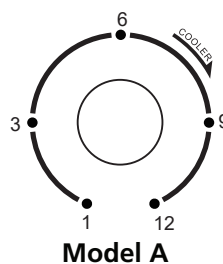

## SELECTOR

To set the desired operation mode, turn the SELECTOR to the appropriate position.(see the description in previous page)

### For example:

To obtain maximum cooling effect in hot summer, select position HIGH COOL on the SELECTOR.

When the SELECTOR is set at "HIGH FAN" position, the fan only is actuated so that the air is circulated without cooling effect.

### CAUTION:

If the SELECTOR is turned off or set to fan mode from cooling mode, wait for at least 3 minutes before resetting to cooling mode. When turning the SELECTOR from LOW COOL(HEAT) to HIGH COOL(HEAT), keep your speed slow and remember not to change the operation mode too often.

### For example:

To obtain maximum cooling effect in hot summer, select position HIGH COOL on the SELECTOR. When the SELECTOR is set at "HIGH FAN" position, the fan only is actuated so that the air is circulated without cooling effect.

**IMPORTANT:** If the SELECTOR is turned off or set to fan mode from cooling mode, wait for at least 3 minutes before resetting to cooling mode. When turning the SELECTOR from LOW COOL(HEAT) to HIGH COOL(HEAT), keep your speed slow and remember not to change the operation mode too often .

## SELECTOR

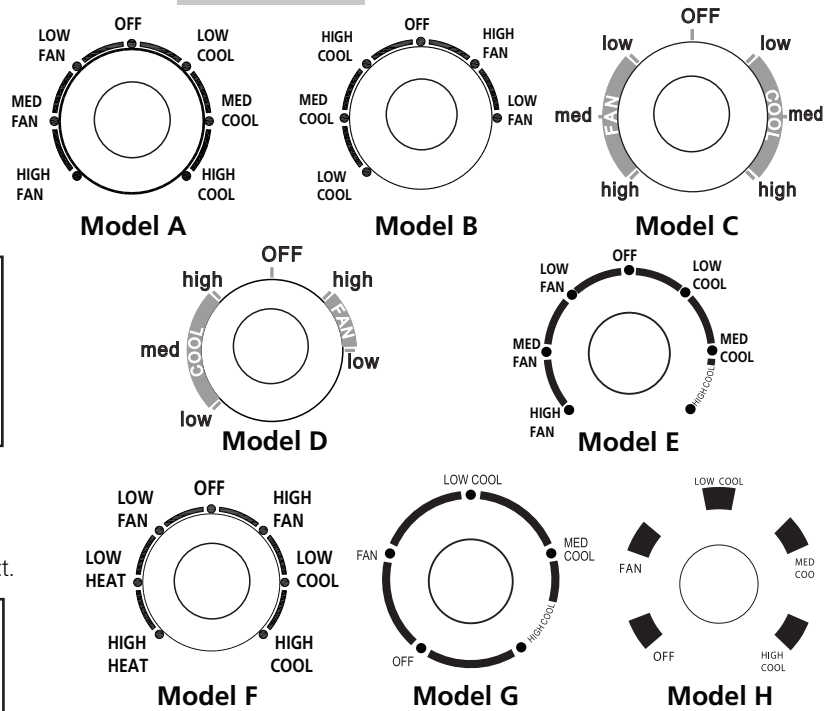

## Operation panel cover (some units)

For the units with operation panel cover (see the left figures of A & B)

1. Grasp the top or the left of the operation cover and pull it to open it.
2. Close the operation cover and press the cover again until it snaps into the locked position.

DO NOT press or swing the opened operation cover.

## Air direction control

### • Horizontal airflow adjustment

#### For the units with AUTO SWING switch(Automatically)

When the AUTO SWING switch is turned to "ON" position, the horizontal airflow louvers oscillate right and left sweeping the cold air alternately to obtain comfortable cooling. The louvers may be stopped at any position when the AUTO SWING switch is turned to "OFF" position(see Fig.C).

#### For the units with manual control lever(Manually)

To adjust horizontal airflow direction, move the lever gently to the left or right by hand until the desired horizontal airflow direction is obtained(see Fig.D).

### • Vertical airflow adjustment(Manually)

When the unit is operating, use the hand to adjust the louvers to change the vertical airflow direction.The vertical angle of air flow can be set by gripping the louver and move to the desired position (see Fig.E).

For some units, the connecting rod of the louver is provided with a convex block , it can be moved between the three grooves on the left side of frame at an angle of 0-15 degrees(see Fig.F).

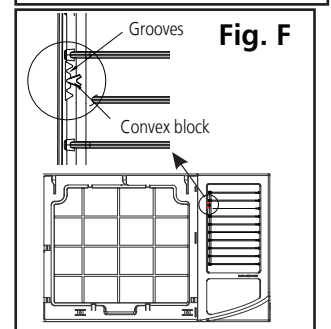
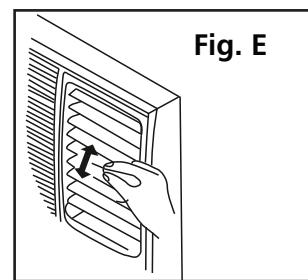
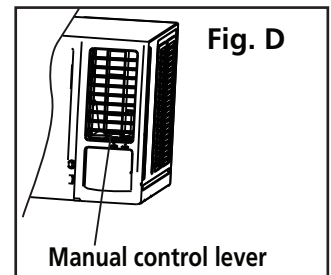
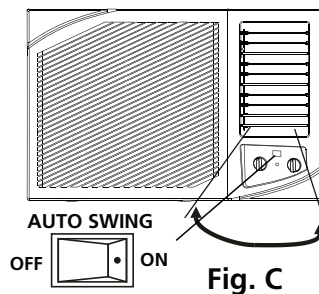
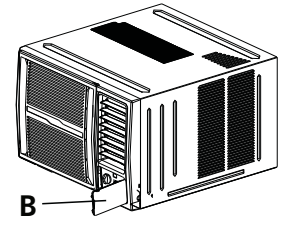
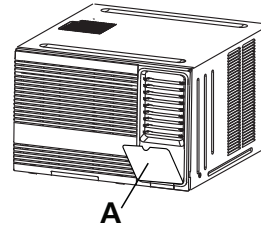

## CARE AND MAINTENANCE

### Cleaning Your Unit



### BEFORE CLEANING OR MAINTENANCE

**ALWAYS TURN OFF YOUR AIR CONDITIONER SYSTEM AND DISCONNECT ITS POWER SUPPLY BEFORE CLEANING OR MAINTENANCE.**

## ! IMPORTANT

The cabinet and front panel may be dusted with an oil-free cloth or washed with a cloth dampened in a solution of warm water and mild liquid dishwashing detergent. Rinse thoroughly and wipe dry.

- **Do not** use inflammable sprays such as lacquer or hair spray near the air conditioner
- **Do not** use benzene, alcohol, gasoline, acid, paint thinner, polishing powder or other solvents to clean the unit. The unit can be damaged.
- **Do not** use water hotter than 50°C (122°F) to clean the front panel. This can cause the panel to deform or become discolored.
- Excess water in or around the controls may cause damage to the air conditioner. Be sure to wring excess water from the cloth before wipe it clean.

## Cleaning Your Air Filter

A clogged air filter can reduce the cooling efficiency of your unit and increase operating noise. Make sure to clean the filter once every two weeks (or as necessary) during periods of frequent operation.

1. Hold the slot under the front panel, then uplift it outwards, and remove the front panel.
2. Pinch the handle under the air filter and make the air filter arched, remove it from the slot from underside to upside (Model A). Grasp the handle of the filter, then slide it downwards to remove the filter (Model B).
3. Clean the filter with warm, soapy water. The water should be below 40°C (104°F) to prevent distortion of the filter.
4. If your filter has a small air freshening filter, clean this air freshening filter with a hand-held vacuum.
5. Rinse the air filter with fresh water, then shake off excess water.
6. Dry it in a cool, dry place, and refrain from exposing it to direct sunlight.

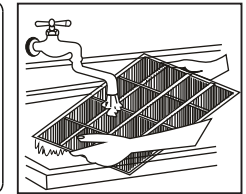
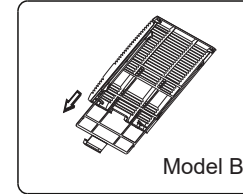
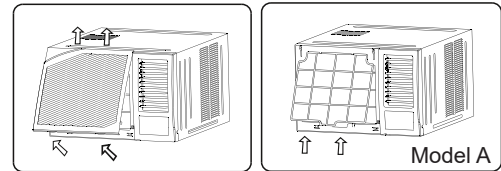

If your filter has a small air freshening filter (optional), it can be installed at any of the four positions, install it at the position as you like. Clean it with a hand-held vacuum.

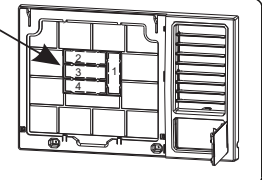

## ! CAUTION

**NEVER** operate the air conditioner without the air filter, as dust/dirt particles can contribute to equipment failure.

## Winter Storage

If you plan to store the air conditioner during the winter, remove it carefully from the window according to the installation instructions. Cover it with plastic or return it to the original carton.

## WATER DRAINAGE

The condensed water can be treated as follows:

**Bottom drainage** (Applicable for the units designed with bottom drain hole only.)

- Remove the rubber plug from the bottom of cabinet (if any)
- Take out the drain pan and screws from accessory.
- Fix the drain pan onto the bottom of cabinet by screws.
- Connect an extension drain hose (locally purchased) to the outlet of drain tray.

**NOTE:** The bottom drainage will slightly affect cooling performance, but it can reduce the noise caused by spraying the condensed water. For pump heating, the bottom drainage must be chosen.

### Back drainage

- Fit the seal onto the drain joint (provided as accessory).
- Insert the drain joint to the back drainage hole, and rotate it by 90° to be well fitted.
- Connect an extension drain hose (locally purchased according to the installation length request) to the drain joint.
- Make sure to plug the bottom drain hole by rubber plug.

**NOTE:** The back drainage will slightly affect cooling performance, but will reduce the noise caused by spraying the condensed water.

### Non-drainage

If you choose non-drainage when cooling, both the bottom and the back drain holes of the unit should be plugged with rubber plugs. The condensed water will be sprayed to condenser, and will improve the cooling performance.

### NOTE:

When you choose non-drainage, the air conditioner will be perfect cooling efficiency, but big noise may be caused by spraying the condensed water. Please do not choose it if you are sensitive to the noise.

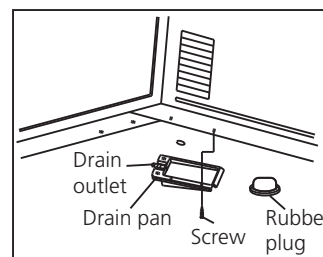
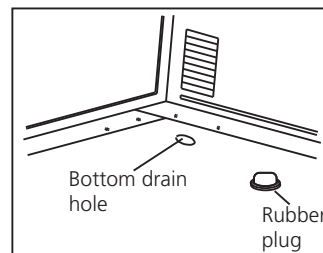

Bottom drainage

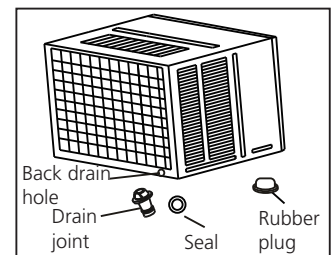

Back drainage

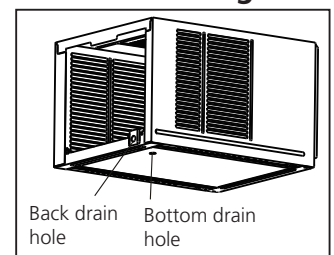

Non-drainage

## Note on the product

- The rated cooling performance is tested under non-drainage status.
- Make sure that water will not leak from the surrounding area when rubber plug and joint were used. Please seal it in case leakage is found.



# INSTALLATION INSTRUCTIONS

## Prior to installation

**CAUTION:** Before installing, remove all packaging from inside the carton, along with any inserts placed into the side louvers.

### Step 1: Select the best location

1. To avoid vibration and noise, make sure the unit is installed securely and firmly.
2. Install the unit where the sunlight does not shine directly on the unit. If the unit receives direct sunlight, build an awning to shade the cabinet.
3. There should be no obstacle, such as a fence or wall, within 50cm from the back of the cabinet because it will prevent heat radiation of the condenser. Restriction of outside air will greatly reduce the cooling and heating efficiency of the air conditioner.
4. Install the unit a little obliquely downward to outside not to leak the condensed water into the room (about 5~7mm).
5. Install the unit with its bottom portion 75~150cm above the floor level.
6. The power cord must be connected to an independent circuit. The yellow/green wire must be grounded.



All side louvers of the cabinet must remain exposed to the outside of the structure

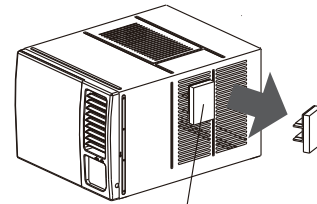

Remove inserts placed into the side louvers

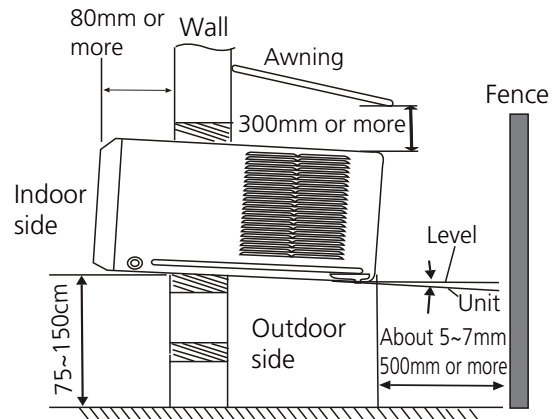

Option A

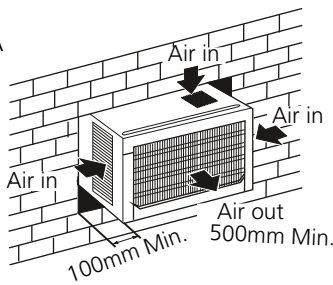

Option B

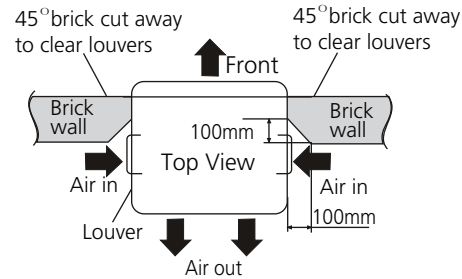

### Step 2: Remove the front panel and air filter

1. Take out the air conditioner from its packaging.
2. Hold the slot under the front panel, then uplift it outwards, and remove the front panel (See Fig. 1)
3. Grip the tab on the end of the filter, lift it up, then pull it towards yourself, pull the filter out (see Fig. 2)

### Step 3: Remove the frame

1. Remove two screws at the bottom of the frame. (See Fig. 3)
  2. Hold the left bottom side of the frame, lift it up to unlatch the lower side, remove it toward you (See Fig. 4)
- NOTE: For some units the front panel and frame do not install on the machine placed at the back of the unit, step 2 and step 3 do not need.

### Step 4: Remove the cabinet

NOTE: There are slight differences on removing the cabinet according to the different models.

#### Model A:

1. Remove one screw securing the chassis fixing bracket, then take down the chassis fixing bracket as shown in Fig. 5A.
2. Grasp the handle on the chassis and carefully slide the air conditioner out of the cabinet. (see Fig. 6)

#### Model B:

1. Remove one screw securing the chassis fixing bracket, then take down the chassis fixing bracket. Remove two screws located on the back of the cabinet as shown in Fig. 5B.
2. Grasp the handle on the chassis and carefully slide the air conditioner out of the cabinet. (see Fig. 6)

#### Model C:

1. Remove four screws located on both sides and the back of the cabinet as shown in Fig. 5C.
2. Grasp the handle on the chassis and carefully slide the air conditioner out of the cabinet. (see Fig. 6)

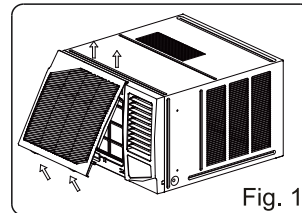

Fig. 1

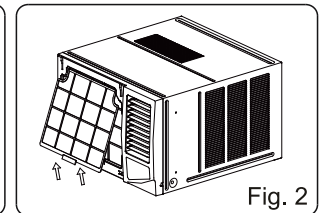

Fig. 2

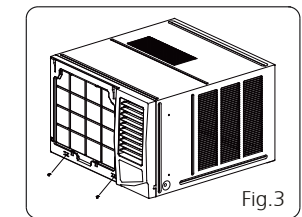

Fig. 3

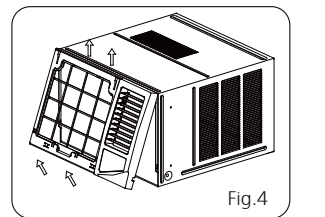

Fig. 4

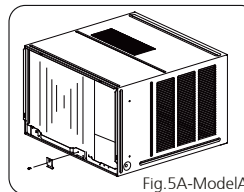

Fig. 5A-Model A

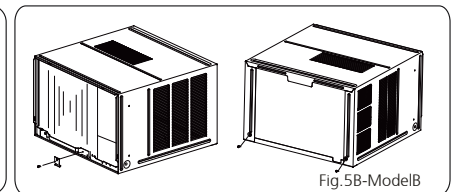

Fig. 5B-Model B

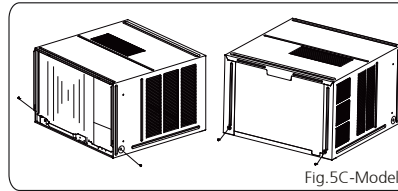

Fig. 5C-Model C

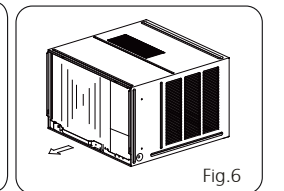
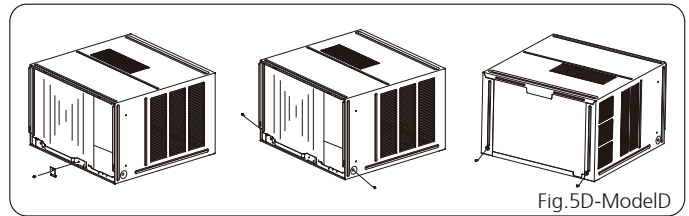

Fig. 6

### Model D:

1. Remove one screw securing the chassis fixing bracket, then take down the chassis fixing bracket.(see Fig.5D)
2. Remove four screws located on both sides and the back of the cabinet as shown in Fig.5D.
3. Grasp the handle on the chassis and carefully slide the air conditioner out of the cabinet.(see Fig.6)



### Step 5: Install the cabinet

**NOTE:** Unit may be supported by a solid frame from below or by a hanger from a solid overhead support(not supplied, purchase separately, please contact the dealer).

1. When need to drain off water, install the drain plug on the chassis board.
2. Prepare the hole in the wall so that the bottom of the cabinet is well supported, the top has minimum clearance and the air inlet louvers have clearance as shown in previous page (Fig. Option A & B). Holes from the outside through to the cavity should be sealed. The cabinet should slop down towards the rear by about 5~7mm to allow water formed during operation to drain.
3. Install the cabinet into the wall and secure. Ensure the foam seals are not damaged. Flash, seal or fill gaps around the inside and outside to provide satisfactory appearance and protection against the weather, insects and rodents. (see Fig.7)

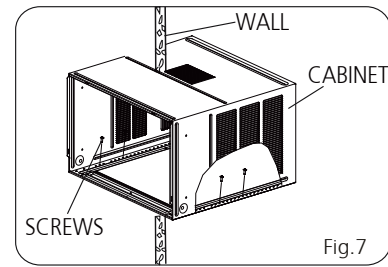
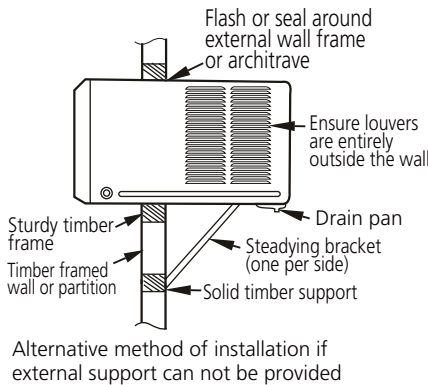
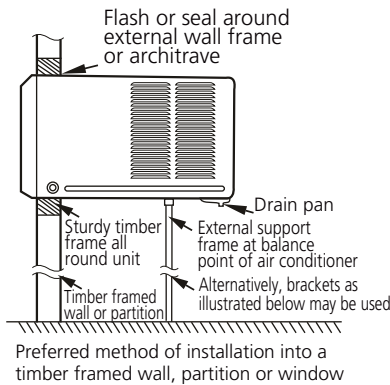

### Step 6: Install the unit into the cabinet

1. Slide the unit into the cabinet until it is firmly against the rear of the cabinet. Care is required to ensure the foam sealing strips on the cabinet remain in position (See Fig.8).
2. Connect the air conditioner to the power and position excess cord length beneath the air conditioner base.
3. Engage the chassis fixing brackets into the bottom cabinet rail and secure to the base with the screw provided.

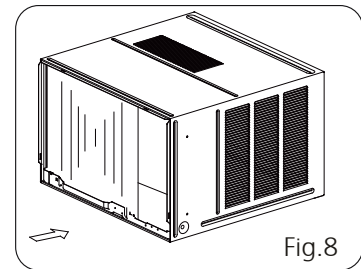

### Step 7: Install the frame

1. Hook the upper edge of the frame(see Fig.9).
2. Press the both side and lower edge of the frame, and secure it with the two screws at the bottom of the frame.( See Fig. 10)

### Step 8: Install the air filter and front panel

1. Insert the air filter into the frame's slot from upside to underside. (See Fig. 2)
2. Hang the front panel on the frame's buckle, then press the front panel into the frame's slot until you hear a click (see Fig.11).
3. Switch unit on. Check for operation of the unit and check for vibration after installation.
4. Fit the drain pan to the cabinet and run a drain hose to a suitable location if required.

**NOTE: For the unit with power cord comes out from left side,** please perform the following steps:

1. Pull the power cord to the left side straightly(See Fig.a & b).
2. Wrap the PVC protecting sheath on the power cord with cable ties in the hole position (see Fig.c).
3. Tie up the power cord on the frame (see Fig.d & e) (Applicable for units with body dimension of 600mm\*380mm\*560mm only)
4. Install the frame and front panel according to the above Step 6 and Step 7.

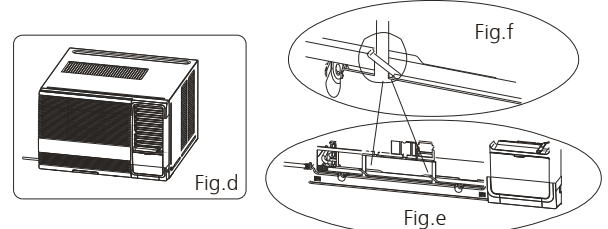
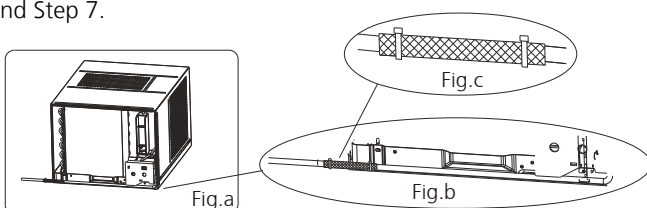
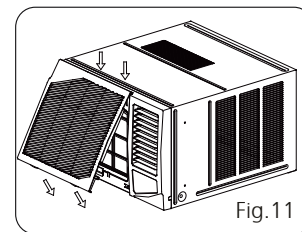
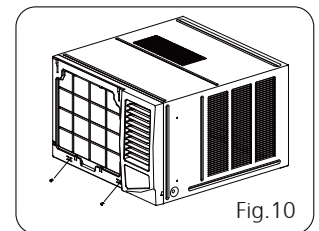
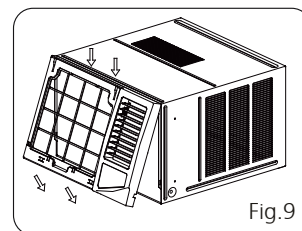

# Troubleshooting



## SAFETY PRECAUTIONS

If ANY of the following conditions occurs, turn off your unit immediately!

- The power cord is damaged or abnormally warm
- You smell a burning odor
- The unit emits loud or abnormal sounds
- A power fuse blows or the circuit breaker frequently trips
- Water or other objects fall into or out of the unit

**DO NOT ATTEMPT TO FIX THESE YOURSELF! CONTACT AN AUTHORIZED SERVICE PROVIDER IMMEDIATELY!**

## Common Issues

The following problems are not a malfunction and in most situations will not require repairs.

| Issue  | Possible Causes   |
|--|---|
| <b>Unit does not turn on when pressing ON/OFF button</b>   | Wall plug disconnected. Push plug firmly into wall outlet.  |
|  | House fuse blown or circuit breaker tripped. Replace fuse with time delay type or reset circuit breaker.  |
|  | Selector Control in OFF position. Turn selector to the desired FAN or COOL setting.   |
|  | Unit turned off by moving thermostat to a higher number and then immediately turning back to a colder number. Wait approximately 3 minutes. Listen for compressor to start. |
|  | Unit turned off and then on too quickly. Turn unit off and wait for 3 minutes before restarting.  |
|  | Thermostat set too low. Adjust thermostat to higher number for cooling.   |
| <b>Air from unit does not feel cold enough</b>   | Turn selector to a higher COOL position.  |
|  | Thermostat set too warm. Set thermostat to colder temperature.  |
|  | Room temperature below 18°C(64°F). Cooling may not occur until room temperature rise above 18°C(64°F).  |
|  | Temperature sensing tube touching cold coil, located behind air filter. Straighten tube away from coil.   |
| <b>Air conditioner cooling, but room is too warm-ice forming on cooling coil behind decorative front</b>                     | Outdoor temperature below 18°C(64°F). To defrost the coil, set selector to FAN position. Then, set thermostat to warmer position.   |
|  | Air filter may be dirty. Clean filter. Refer to Care and Maintenance section. To defrost, set selector to FAN.  |
|  | Thermostat set too cold for night-time cooling. To defrost the coil, set selector to a FAN position. Then, set thermostat to a warmer position.                             |
|  | Dirty air filter- air restricted. Clean air filter. Refer to Care and Maintenance section.  |
|  | Thermostat set too warm. Turn thermostat clockwise to a colder setting.   |
|  | All directional louvers positioned improperly. Position louvers for better air distribution.  |
|  | Front of units is blocked by drapes, blinds, furniture, etc. - restricts air distribution. Clear blockage in front of unit.   |
|  | Doors, windows, registers, etc. Open- cold air escapes. Close doors, windows, registers.  |
| Unit recently turned on in hot room. Allow additional time to remove "Stored heat" from walls, ceiling, floor and furniture. |   |
| <b>Air conditioner turns on and off rapidly</b>  | Dirty air filter - air restricted. Clean air filter.  |
|  | Outside temperature extremely hot. Set to high cool to bring air past cooling coils more frequently.  |
| <b>Noise when unit is cooling</b>  | Air movement sound. This is normal. If too loud, turn selector to lower FAN setting.  |
|  | Sound of fan hitting water-moisture removal system. This is normal when humidity is high. Close doors, windows and registers.   |
|  | Window vibration - poor installation. Refer to installation instructions or check with installer.   |
| <b>Water dripping INSIDE when unit is cooling</b>  | Improper installation. Tilt air conditioner slightly to the outside to allow water drainage. Refer to installation instructions - check with installer.                     |
| <b>Water dripping OUTSIDE when unit is cooling</b>   | Unit removing large quantity of moisture from humid room. This is normal during excessively humid days.   |

# SPECIFICATIONS

## Unit dimensions:

| MODEL(But/h) | BODY DIMENSION(WxHxD)(mm) |
|--------------|---------------------------|
| 5000~6000    | 445x320x415               |
|              | 450x346x535               |
| 7000~9000    | 450x346x535               |
|              | 450x346x585               |
| 9000~12000   | 450x346x585               |
|              | 560x400x640               |
|              | 600x380x560               |
| 15000~24000  | 660x428x680               |
|              | 660x428x780               |

**Note:** For the different customization requirements, the depth of the panel may be slightly different. So the dimension of "D" is for reference only.

## Choose the right cable size

The size of the power supply cable, signal cable, fuse, and switch needed is determined by the maximum current of the unit. The maximum current is indicated on the nameplate located on the side panel of the unit. Refer to this nameplate to choose the right cable, fuse, or switch.

### Minimum nominal cross-sectional area of conductors:

| Rated Current of Appliance (A) | Nominal Cross-Sectional Area (mm <sup>2</sup> ) |
|--------------------------------|---|
| > 3 and ≤ 6                    | 0.75  |
| > 6 and ≤ 10                   | 1   |
| > 10 and ≤ 16                  | 1.5   |
| > 16 and ≤ 25                  | 2.5   |
| > 25 and ≤ 32                  | 4   |
| > 32 and ≤ 40                  | 6   |

**NOTE:** TO be in compliance EN61000-3-11, the product MWT2F-21CM-QB4 shall be connected only to a supply of the system impedance:  $I_{Zsysl}=0.156$  ohms or less; the product MWT2F1-22CM-QB4 shall be connected only to a supply of the system impedance:  $I_{Zsysl}=0.132$  ohms or less; the product MWT2F1-22CM-QB8 shall be connected only to a supply of the system impedance:  $I_{Zsysl}=0.077$  ohms or less. Before connect the product to public power network, please consult your local power supply authority to ensure the power network meet above requirement.

## Packing and unpacking the unit

### Instructions for packing / unpacking the unit:

#### Unpacking:

1. Cut the packing belt and sealing tape on the carton with a knife.
2. Remove the carton.
3. Remove the left and right package foam or the upper and lower packaging foam, and take out the accessory package if it is included.
4. Untie the packaging bag.
5. Take out the unit.

#### Packing:

1. Put the unit into the packing bag.
2. Attach the left and right package foam or the upper and lower packaging foam to the unit.
3. Put the unit into the carton, then put accessory package in.
4. Seal carton with the tape.
5. Using the packing belt if necessary.

**NOTE:** Please keep all packaging items if you may need in the future

**The design and specifications are subject to change without prior notice for product improvement. Consult with the sales agency or manufacturer for details. Any updates to the manual will be uploaded to the service website, please check for the latest version.**

**CW004UI-F(E)MN1  
16120300000900  
2021.07.28**

## 此面及后面的页面无需印刷

技术要求:

- 1.80克/平方双胶纸
- 2.尺寸: 210\*290
- 3.颜色: 黑白
- 4.注意: 排版时注意页码数字都是靠外面的, 以便翻阅
- 5.装订。

备注:

1. 基准说明书只适合基准面板和带基准标贴的机器, 如果是订制产生的标贴形状和功能跟基准相同, 也可以借用基准说明书。
2. 基准说明书为单英文版本, 不含型号及商标, 也无制造商信息, 请业务根据所销售国家或者区域的法规要求 (也可以咨询认证工程师), 自行判断是否可以直接使用基准说明书, 还是重新申请订单编码说明书, 使用对应国家的官方语言, 增加型号及其它法规要求信息。
3. 客户订制面板和功能标贴, 如果显示功能跟基准相同, 可以直接使用基准说明书 (基准不区分面板差异, 实际标贴效果图形, 如果客户要求体现实际面板效果, 那制单就按客户要求重新做书, 只需替换P6-7页的旋钮功能说明内容, 将对应的标贴图形, 整机外观图替换上去。)
- 4 **P12页最后NOTE:**内容只适合部分由于电压波动和闪烁不合格的机型, 要求增加阻抗声明, 其它无不合格要求的机型可以直接删除部分内容。

2021年7月修订 12页增加打包说明